

WinGuard®

ALUMINUM
IMPACT
TECHNICAL
GUIDE

The #1 brand of impact-resistant windows and doors in the nation.



T A B L E O F C O N T E N T S

General Specifications.....	4
Product Quick Reference Guide.....	6
Single Hung (SH7700A).....	7
Horizontal Roller (HR7710A).....	10
Casement (CA740).....	14
Awning & Casement Picture Window (AW/CAPW740).....	17
Fixed Lite Picture Window & Architecturals (PW/AR7720A).....	19
Preferred Sliding Glass Door (SGD770).....	21
Premium Sliding Glass Door (SGD780).....	23
Essential French Door (FD101H).....	26
Preferred French Door (FD750).....	28



GENERAL SPECIFICATIONS

PERFORMANCE

- Tested and certified to rigorous Miami-Dade protocols
- Qualified as large and small missile
- Florida Building Code approved
- National Fenestration Rating Council (NFRC) certified

ENERGY PERFORMANCE

- Laminated insulating glass available
- High performance Low-E glass available
- Argon gas available with laminated insulating glass
- Various heat reducing glass tints

CONTINUOUS PROTECTION

- Glass options that meet the Sea Turtle Protection Code
- Deters intruders
- Protects against high winds and wind-borne debris
- Filters out 99% of UV rays and protects against damage caused by UV rays
- Reduces outside noise

FEATURES

- Custom built to homeowners' specifications

RESIDENTIAL WARRANTY

- 10 years frame and laminated glass*

STYLES

- Single Hung
- Horizontal Roller
- Casement
- Projected Awning
- Picture Window
- Architectural Shapes
- Sliding Glass Doors
- French Doors
- Mull Bars and Mull Clips

FRAMES

- Heavy-duty extruded aluminum
- Nominal 2-3/4" window frame depth
- 1/2" Flange frame type with all windows
- Integral Nail-Fin and Equal Leg frame types available with Single Hung, Horizontal Roller, Picture Window, and Architectural Shapes

*Some restrictions may apply. Refer to full PGT® Custom Windows and Doors warranty for full details.

GLAZING

- Standard: Impact-resistant laminated glass
- Optional: Laminated insulating glass
- All products are exterior glazed
- All products are silicone glazed for greater strength and seal
- Windows and Sliding Glass Doors have a structural extruded aluminum glazing bead for stronger resistance to wind load

FRAME COLORS

- Standard: White
- Optional: Bronze, Black, Clear Anodize
- Custom colors and finishes available

GLASS OPTIONS

- Standard Tints: Bronze, Gray, Green
- Premium Tints: Solar Cool Bronze, Azure Blue
- Low-E: EnergyShield, EnergyShield Max
- Privacy Glass: Obscure Glass, White Interlayer
- Argon gas

COLONIAL GRIDS*

Laminated Glass

- Double Applied: 1" Raised exterior grid with Flatbar interior

Laminated Insulating Glass

- Colonial Insulating: 9/16" Flat grid between the glass

OPENING SIZES

Window Opening Size Formulas

Openings are calculated using 1/8" shim space (maximum 1/4" allowed)

Masonry Opening with 1x Bucks and Precast Sill	Masonry Opening with 1x Bucks and Poured Sill	Wood Frame Opening with Drywall Butted
TTT window width + 3/4"	TTT window width + 3/4"	DLO window width + 1/4"
TTT window height	TTT window height + 3/4"	DLO window height + 1/4"

French Door and By-Pass Sliding Glass Door Finished Opening Size Formulas

Openings calculated using 1/8" shim space (maximum 1/4" allowed)

Masonry Opening with No Bucks:	Masonry Opening with 1x Bucks:	Masonry Opening with 2x Bucks:
Door width + 1/4"	Door width + 1-3/4"	Door width + 3-1/4"
Door height + 1/8"	Door height + 7/8"	Door height + 1-5/8"

Visit Prozone to order our convenient openings size chart pocket cards.

Note: PGT® reserves the right to change material design and/or construction without notice or liability.

*FD650/750 + SGD680/780 excluded. These only have Ogee Raised internal/external grid.

PRODUCT QUICK REFERENCE GUIDE

Product Styles and Sizes					Frame Styles			Frame Colors		Test Methods and Certifications		
Product Style	Configuration	Nominal Frame Depth	Minimum Size (tip-to-tip frame size)	Maximum Size (tip-to-tip frame size)	Flange	Integral Nail Fin	Equal Leg	White, Bronze, Black, CLR Anodize	Custom Colors	TAS 201 / 202 / 203		
										Design Pressure	Miami-Dade NOA	Florida Building Code
Single Hung (SH700A)	O/X	2-3/4"	17" x 24"	53-1/8" x 84"	■	■	■	■	■	+80/-110	■	■
Horizontal Roller (HR7710A)	OX, XO	2-3/4"	19-3/4" x 18" 28" x 14-5/8"	76" x 76"	■	■	■	■	■	+80/-110	■	■
	XOX-1/4	2-3/4"	42" x 18" 53" x 14-5/8"	120" x 63"	■	■	■	■	■	+80/-110	■	■
	XOX-1/3	2-3/4"	35-1/4" x 18" 42" x 14-5/8"	113-5/8" x 63"	■	■	■	■	■	+80/-110	■	■
Casement (CA740)	X	2-3/4"	18-1/2" x 17"	37" x 76" 33-1/2" x 84"	■			■	■	+90/-130	■	■
	XX	2-3/4"	37" x 17"	74" x 76" 67" x 84"	■			■	■	+90/-130	■	■
	XOX-1/4	2-3/4"	74" x 17"	120" x 76" 108" x 84"	■			■	■	+90/-130	■	■
	XOX-1/3	2-3/4"	55-1/2" x 17"	111" x 76" 100-1/2" x 84"	■			■	■	+90/-130	■	■
Awning (AW740)	X	2-3/4"	22-1/2" x 17"	60" x 39" 27-7/8" x 84"	■			■	■	+90/-130	■	■
Picture Window / Architectural+ (PW/AR7720A)	O	2-3/4"	14-1/2" x 14-1/2"	Up to 42 sq. ft.	■	■	■	■	■	+90/-130	■	■
	O	2-3/4"	18" x 18"	Up to 32 sq. ft.	■			■	■	+90/-130	■	■
Sliding Glass Doors (SGD770)	By-pass or Pocket and 90° or 135° Corners	2-track 5-1/16" 4-track 9-5/32"	43" x 30"	5'0" x 8'0" 4'0" x 10'0" panel			■	■	■	+60/-60	■	■
				4'0" x 8'0" panel			■	■	■	+90/-130	■	■
				4'0" x 9'0" panel			■	■	■	+90/-110	■	■
	By-pass or Pocket and 90° or 135° Corners	2-track 6-25/32" 4-track 11-27/32"	50-3/8" x 35-3/4"	5'0" x 10'0" panel			■	■	■	+86.7/-95	■	■
				4'0" x 12'0" panel			■	■	■	+59.6/-65.2	■	■
				4'0" x 10'0" 5'0" x 8'0" panel			■	■	■	+105/-115	■	■
French Doors / Sidelites (FD750)	X	3"	20" x 36"	37-1/2" x 95-3/4"			■	■		+75/-75	■	■
				71-3/4" x 95-3/4"			■	■		+75/-75	■	■
				36-3/4" x 95-3/4"			■	■		+75/-75	■	■
	XX	3-5/8"	20" x 35-3/4"	37" x 95-3/4"			■	■	■	+100/-100	■	■
				71-3/4" x 95-3/4"			■	■	■	+100/-100	■	■
				36-11/16" x 95-3/4"			■	■	■	+100/-100	■	■
O (Narrow)	3-5/8"	10-11/16" x 35-3/4"	36-11/16" x 95-3/4"			■	■	■	+100/-100	■	■	
			36-11/16" x 95-3/4"			■	■	■	+100/-100	■	■	

+ Minimum/Maximum sizes may vary by shape. Refer to ClearQuote for specific shape sizes.

W I N D O W S

Single Hung

(SH7700A)

FEATURES:

- 1/2" flange frame
- 5/16" laminated glass
- Equal lite glass configuration
- Spiral balances
- Stainless steel assembly screws
- Roll-formed half screen with 1816 charcoal mesh

OPTIONS:

- Commodity, Modular, Nominal, and Custom sizes
- Integral Nail Fin & Equal Leg frame
- Laminated insulating glass
- EnergyShield & EnergyShield Max Low-E
- Argon gas
- Standard or ProView (Oriel) sash styles
- Radius Top frame style
- Bottom sash locks
- Vent Latches
- Window Opening Control Device (WOCD)
- High rise sill
- High design pressure options

PERFORMANCE:

- Flange sizes up to 53 1/8" x 84"
- Design pressures up to +80/-110

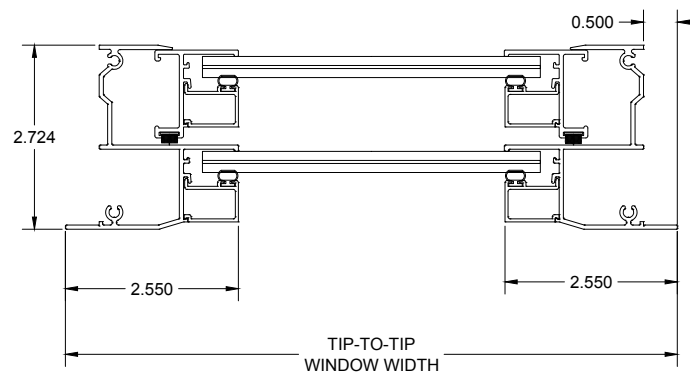
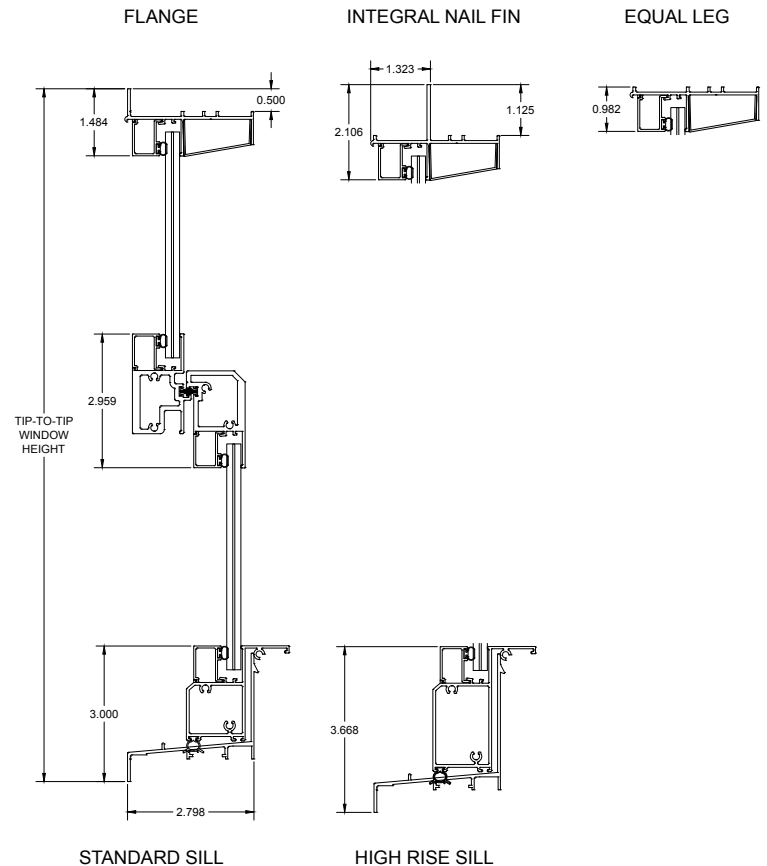

Single Hung (SH7700A)

COMMODITY FLANGE* SIZES

Height	Width			
	19 1/8"	26 1/2"	37"	53 1/8"
26"	12	H32	22	32
38 3/8"	13	H33	23	33
50 5/8"	14	H34	24	34
59 1/2"+	14EH	H34EH	24EH	34EH
63"+	15	H35	25	35
76"	16	H36	26	36
84"	17	H37	27	37

Egress is 5.0 SF or greater

Egress is 5.7 SF or greater

MODULAR FLANGE* SIZES

Height	Width				
	24"	32"	40"	44"	48"
26"	2022	2822	3422	3822	4022
38 3/8"	2033	2833	3433	3833	4033
50 5/8"	2043	2843	3443	3843	4043
59 1/2"+	2043EH	2843EH	3443EH	3843EH	4043EH
63"	2053	2853	3453	3853	4053
76"	2064	2864	3464	3864	4064

* Flange sizes shown. Integral Nail Fin and Equal Leg frame, deduct 1" from both width and height.

NOMINAL INTEGRAL FIN SIZES

Height	Width						
	23 1/2"	29 1/2"	31 1/2"	35 1/2"	41 1/2"	43 1/2"	47 1/2"
35 1/2"	2030	2630	2830	3030	3630	3830	4030
43 1/2"	2038	2638	2838	3038	3638	3838	4038
47 1/2"	2040	2640	2840	3040	3640	3840	4040
49 1/2"	2042	2642	2842	3042	3642	3842	4042
53 1/2"	2046	2646	2846	3046	3646	3846	4046
59 1/2"	2050	2650	2850	3050	3650	3850	4050
61 1/2"	2052	2652	2852	3052	3652	3852	4052
65 1/2"	2056	2656	2856	3056	3656	3856	4056
71 1/2"	2060	2660	2860	3060	3660	3860	4060
73 1/2"	2062	2662	2862	3062	3662	3862	4062

Note: Egress calculations are based upon equal sash, 5/16" laminated glass with standard sill and no options. Calculate additional sizes and configurations by using the formula or ClearQuote.

EGRESS FORMULA

Equal Sash	Flange Frame	Integral Nail Fin & Equal Leg Frame
Clear Opening Width	Tip-to-Tip Window Width - 5.120"	Actual Window Width - 4.120"
Clear Opening Height (Standard Sill)	(Tip-to-Tip Window Height / 2) - 6.234"	(Actual Window Height / 2) - 5.734"
Clear Opening Height (Hi-Rise Sill)	(Tip-to-Tip Window Height / 2) - 7.232"	(Actual Window Height / 2) - 6.732"

Egress Formulas are based upon standard window features. Material or design changes may be made without notice or liability. In the event of discrepancies, only those egress opening sizes displayed in ClearQuote will be honored.

+ EH and 5-high Call Size windows do not follow the standard egress formula. Special modifications are made to meet egress only on these Call Sizes.

STANDARD LITES FOR COLONIAL GRIDS

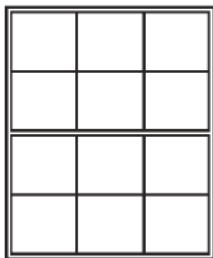

Equal Sash Configuration		
Window width	Up to 31.9"	= 2 lites across (1V) per lite of glass
Window width	32" - 42.9"	= 3 lites across (2V) per lite of glass
Window width	43" - 53.125"	= 4 lites across (3V) per lite of glass
Window height	Up to 31.9"	= 1 lite down (0H) per lite of glass
Window height	32" - 76.9"	= 2 lites down (1H) per lite of glass
Window height	77" - 84"	= 3 lites down (2H) per lite of glass

STANDARD LITES FOR COLONIAL GRIDS

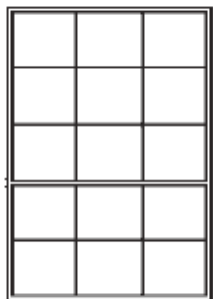

Proview Sash Configuration		
Window width	Up to 31.9"	= 2 lites across (1V) per lite of glass
Window width	32" - 42.9"	= 3 lites across (2V) per lite of glass
Window width	43" - 53.125"	= 4 lites across (3V) per lite of glass
Window height	Up to 31.9"	Vent = 1 lites down (0H) per lite of glass Fixed = 2 lites down (1H) per lite of glass
Window height	32" - 76.9"	Vent = 2 lites down (1H) per lite of glass Fixed = 3 lites down (2H) per lite of glass
Window height	77" - 84"	Vent = 3 lites down (2H) per lite of glass Fixed = 4 lites down (3H) per lite of glass

Horizontal Roller (HR7710A)

FEATURES:

- 1/2" flange frame
- 5/16" laminated glass
- Equal lite glass configuration
- Stainless steel bearing roller
- Stainless steel assembly screws
- Roll-formed half screen with 1816 charcoal mesh

OPTIONS:

- Commodity, Modular, Nominal, and Custom sizes
- Integral Nail Fin & Equal Leg frame
- Laminated insulating glass
- EnergyShield & EnergyShield Max Low-E
- Argon gas
- 2-Lite (XO or OX) or 3-Lite (XOX) configuration
- Vent Latches
- Window Opening Control Device (WOCD)
- Heavy-Duty Meeting Rail
- High design pressure options

PERFORMANCE:

- Flange size 2-Lite configurations up to 76" x 76"
- Flange size 3-Lite configurations up to 120" x 63"
- Design pressures up to +80/-110

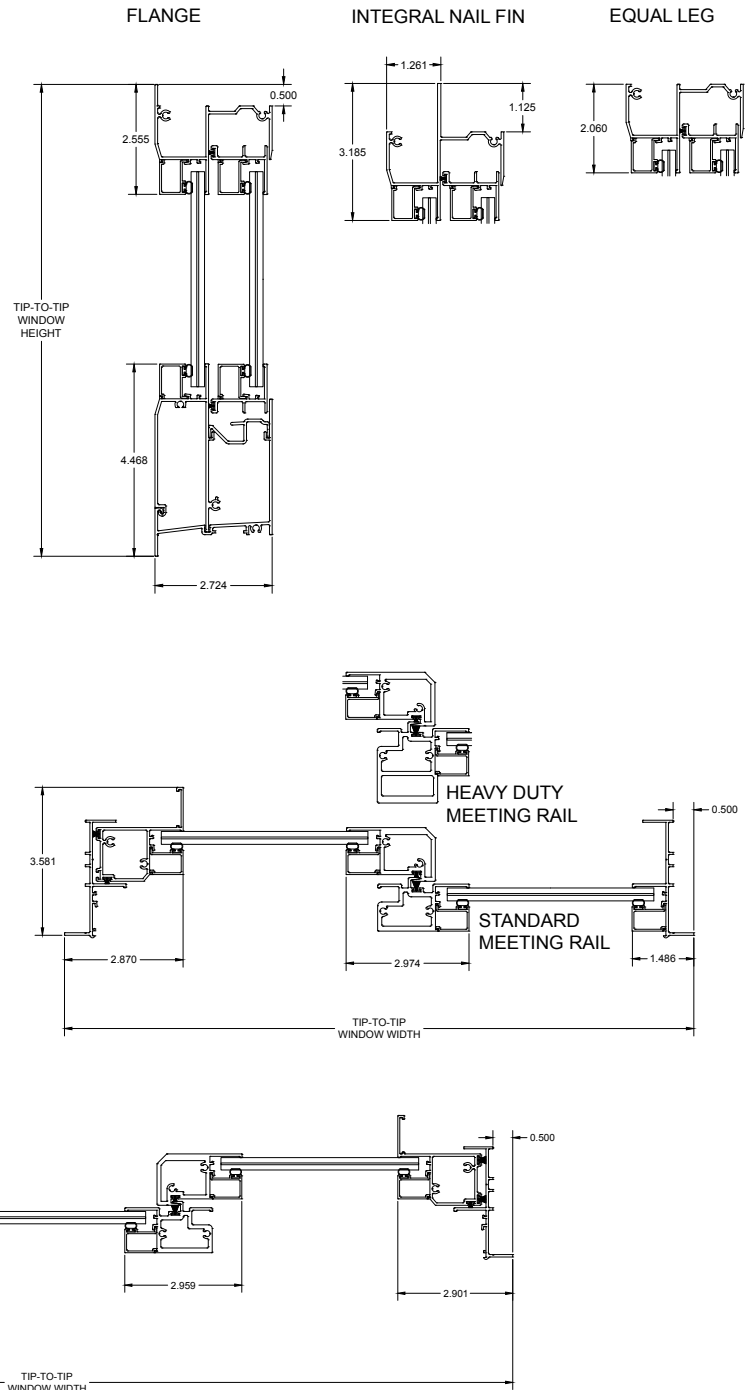

XO/OX COMMODITY FLANGE* SIZES

Height	Width			
	26 1/2"	37"	53 1/8"	74"
26"	H32	22	32	D22
38 3/8"	H33	23	33	D23
50 5/8"	H34	24	34	D24
63"	H35	25	35	D25

Egress is 5.0 SF or greater

Egress is 5.7 SF or greater

XO/OX MODULAR FLANGE* SIZES

Height	Width								
	24"	36"	48"	54"	60"	66"	72"	74"	76"
24"	2020M	3020M	4020M	4620M	5020M	5620M	6020M	6220M	-
26"	2022	3022	4022	4622	5022	5622	6022	-	6422
36"	2030M	3030M	4030M	4630M	5030M	5630M	6030M	6230M	-
38 3/8"	2033	3033	4033	4633	5033	5633	6033	-	6433
48"	2040M	3040M	4040M	4640M	5040M	5640M	6040M	6240M	-
50 5/8"	2043	3043	4043	4643	5043	5643	6043	-	6443
54"	2046M	3046M	4046M	4646M	5046M	5646M	6046M	6246M	-
60"	2050M	3050M	4050M	4650M	5050M	5650M	6050M	6250M	-
63"	2053	3053	4053	4653	5053	5653	6053	-	6453
72"	2060	3060	4060	4660	5060	5660	6060	-	6460
76"	2064	3064	4064	4664	5064	5664	6064	-	6464

* Flange sizes shown. Integral Nail Fin and Equal Leg frame, deduct 1" from both width and height.

XO/OX NOMINAL INTEGRAL FIN SIZES

Height	Width							
	23 1/2"	35 1/2"	47 1/2"	53 1/2"	59 1/2"	65 1/2"	71 1/2"	73 1/2"
23 1/2"	2020	3020	4020	4620	5020	5620	6020	6220
35 1/2"	2030	3030	4030	4630	5030	5630	6030	6230
47 1/2"	2040	3040	4040	4640	5040	5640	6040	6240
53 1/2"	2046	3046	4046	4646	5046	5646	6046	6246
59 1/2"	2050	3050	4050	4650	5050	5650	6050	6250

Horizontal Roller (HR7710A)

XOX 1/4-1/2-1/4 COMMODITY FLANGE* SIZES

Height	Width			
	53 1/8"	74"	106 3/8"	111"
26"	32	D22	D32	T22
38 3/8"	33	D23	D33	T23
50 5/8"	34	D24	D34	T24
63"	35	D25	D35	T25

XOX 1/4-1/2-1/4 MODULAR FLANGE* SIZES

Height	Width						
	48"	60"	72"	84"	96"	108"	120"
24"	4020M	5020M	6020M	7020M	8020M	9020M	10020M
26"	4022	5022	6022	7022	8022	9022	10022
36"	4030M	5030M	6030M	7030M	8030M	9030M	10030M
38 3/8"	4033	5033	6033	7033	8033	9033	10033
48"	4040M	5040M	6040M	7040M	8040M	9040M	10040M
50 5/8"	4043	5043	6043	7043	8043	9043	10043
54"	4046M	5046M	6046M	7046M	8046M	9046M	10046M
60"	4050M	5050M	6050M	7050M	8050M	9050M	10050M
63"	4053	5053	6053	7053	8053	9053	10053

* Flange sizes shown. Integral Nail Fin and Equal Leg frame, deduct 1" from both width and height.

XOX 1/4-1/2-1/4 NOMINAL INTEGRAL FIN SIZES

Height	Width						
	47 1/2"	59 1/2"	71 1/2"	73 1/2"	83 1/2"	95 1/2"	107 1/2"
23 1/2"	4020	5020	6020	6220	7020	8020	9020
35 1/2"	4030	5030	6030	6230	7030	8030	9030
47 1/2"	4040	5040	6040	6240	7040	8040	9040
53 1/2"	4046	5046	6046	6246	7046	8046	9046
59 1/2"	4050	5050	6050	6250	7050	8050	9050

Note: Egress calculations are based upon 5/16" laminated glass and no options.
Calculate additional sizes and configurations by using the formula or ClearQuote.

EGRESS FORMULA

2-Lite XO.OX	Flange Frame	Integral Nail Fin & Equal Leg Frame
Clear Opening Width	(Tip-to-Tip Window Width / 2) - 3.992"	(Tip-to-Tip Window Width / 2) - 3.492"
Clear Opening Height	Tip-to-Tip Window Height - 7.032"	Tip-to-Tip Window Height - 6.032"
3-Lite XOX 1/4-1/2-1/4	Flange Frame	Integral Nail Fin & Equal Leg Frame
Clear Opening Width	(Tip-to-Tip Window Width / 4) - 1.015"	(Tip-to-Tip Window Width / 4) - .765"
Clear Opening Height	Tip-to-Tip Window Height - 7.032"	Tip-to-Tip Window Height - 6.032"
3-Lite XOX 1/3-1/3-1/3	Flange Frame	Integral Nail Fin & Equal Leg Frame
Clear Opening Width	(Tip-to-Tip Window Width / 3) - 3.875"	(Tip-to-Tip Window Width / 3) - 3.543"
Clear Opening Height	Tip-to-Tip Window Height - 7.032"	Tip-to-Tip Window Height - 6.032"

Egress Formulas are based upon standard window features. Material or design changes may be made without notice or liability. In the event of discrepancies, only those egress opening sizes displayed in ClearQuote will be honored.

STANDARD LITES FOR COLONIAL GRIDS

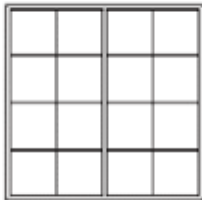

2-Lite Configuration		
Window width	Up to 31.9"	= 1 lites across (0V) per lite of glass
Window width	32" - 71.9"	= 2 lites across (1V) per lite of glass
Window width	72" - 76"	= 3 lites across (2V) per lite of glass
Window height	Up to 31.9"	= 2 lites down (1H) per lite of glass
Window height	32" - 42.9"	= 3 lites down (2H) per lite of glass
Window height	43" - 63.9"	= 4 lites down (3H) per lite of glass
Window height	64" - 76"	= 5 lites down (4H) per lite of glass

STANDARD LITES FOR COLONIAL GRIDS

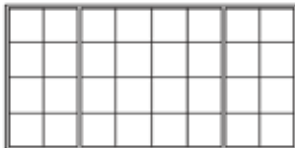

3-Lite Configuration 1/4-1/2-1/4		
Window width	Up to 60"	= Vents - 1 lite across (0V) per lite of glass
		= Fixed - 2 lites across (1V) per lite of glass
Window width	60.001" - 120"	= Vents - 2 lite across (1V) per lite of glass
		= Fixed - 3 lites across (2V) per lite of glass
Window height	Up to 31.9"	= 2 lites down (1H) per lite of glass
Window height	32" - 42.9"	= 3 lites down (2H) per lite of glass
Window height	43" - 63"	= 4 lites down (3H) per lite of glass

Casement (CA740)

FEATURES:

- 1/2" flange frame
- 5/16" laminated glass
- Hinge left or hinge right
- Washable or egress hinge
- Folding nesting handle
- Multi-point lock system
- Extruded screen with 1816 charcoal mesh

OPTIONS:

- Commodity, Modular, and Custom sizes
- Laminated insulating glass
- EnergyShield & EnergyShield Max Low-E
- Argon gas
- Stainless steel hardware package
- Egress washable hinge
- High design pressure options

PERFORMANCE:

- Flange sizes up to 37" x 76" or 33-1/2" x 84"
- Design pressures up to +90/-130

**COMPANION PRODUCTS:
AW740, CA740-O**

- Modular design with matching Awning and Fixed Lite Picture Window for multiple configurations including X, XX, XO, O

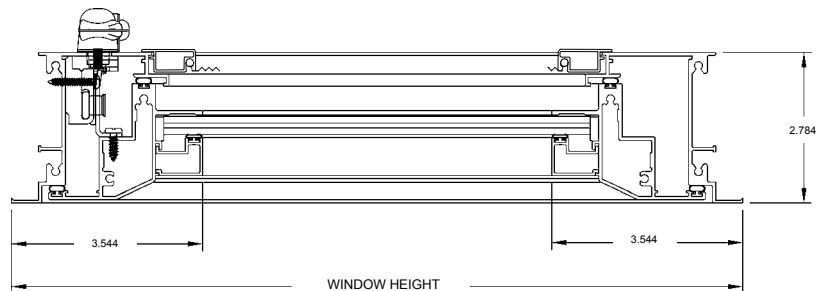
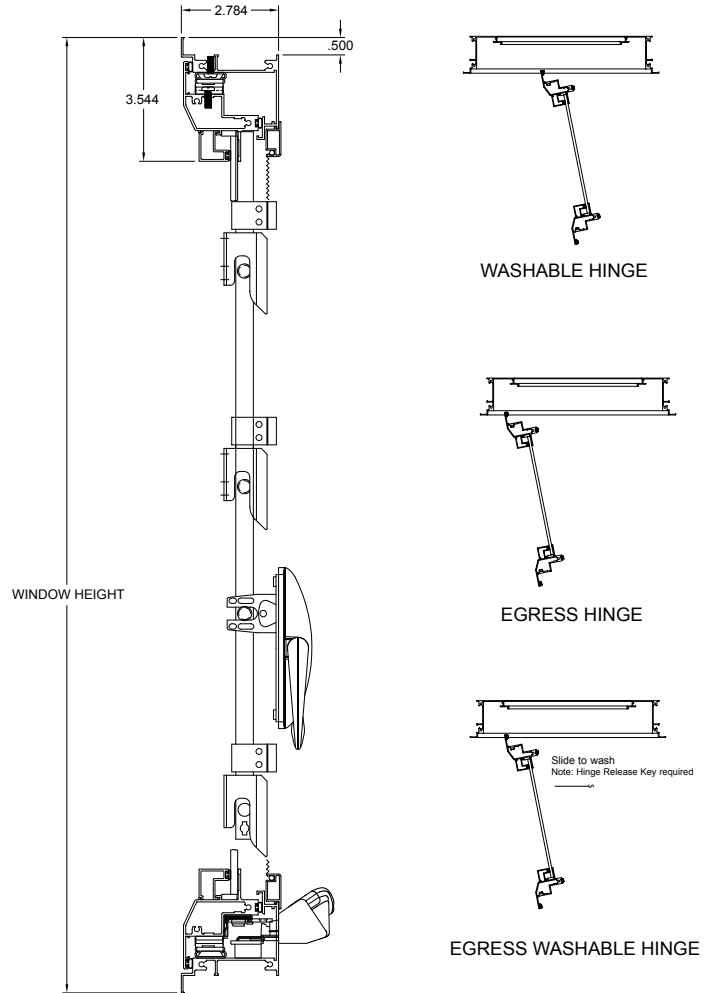

COMMODITY FLANGE SIZES

WASHABLE HINGE	Width		
Height	19 1/8"	26 1/2"	37"
26"	12	H32	22
38 3/8"	13	H33	23
50 5/8"	14	H34	24
63"	15	H35	25
76"	16	H36	26

Egress is 5.0 SF or greater

Egress is 5.7 SF or greater

MODULAR FLANGE SIZES

WASHABLE HINGE	Width				
Height	24"	30"	32"	33 1/2"	36"
24"	2020	2620	2820	2920	3020
36"	2030	2630	2830	2930	3030
48"	2040	2640	2840	2940	3040
60"	2050	2650	2850	2950	3050
72"	2060	2660	2860	2960	3060
84"	2070	2670	2870	2970	-

COMMODITY FLANGE SIZES

ENGRESS HINGE	Width		
Height	19 1/8"	26 1/2"	37"
26"	-	H32	22
38 3/8"	-	H33	23
50 5/8"	-	H34	24
63"	-	H35	25
76"	-	H36	26

MODULAR FLANGE SIZES

ENGRESS HINGE	Width				
Height	24"	30"	32"	33 1/2"	36"
24"	-	2620	2820	2920	3020
36"	-	2630	2830	2930	3030
48"	-	2640	2840	2940	3040
60"	-	2650	2850	2950	3050
72"	-	2660	2860	2960	3060
84"	-	2670	2870	2970	-

Note: Egress calculations are based upon 5/16" laminated glass and no options.

Calculate additional sizes and configurations by using the formula or ClearQuote

Casement (CA740)

EGRESS FORMULA

	Washable Hinge	Egress Hinge
Clear Opening Width	Tip-to-Tip Window Width - 13.500"	Tip-to-Tip Window Width - 7.500"
Clear Opening Height	Tip-to-Tip Window Height - 6.00"	Tip-to-Tip Window Height - 6.00"

Egress Formulas are based upon standard window features. Material or design changes may be made without notice or liability. In the event of discrepancies, only those egress opening sizes displayed in ClearQuote will be honored.

STANDARD LITES FOR COLONIAL GRIDS



Casement X Configuration		
Window width	Up to 30"	= 2 lites across (1V) per lite of glass
Window width	30.001" - 37"	= 3 lites across (2V) per lite of glass
Window height	Up to 30"	= 2 lites down (1H) per lite of glass
Window height	30.001" - 40"	= 3 lites down (2H) per lite of glass
Window height	40.001" - 51"	= 4 lites down (3H) per lite of glass
Window height	51.001" - 65"	= 5 lites down (4H) per lite of glass
Window height	65.001" - 76"	= 6 lites down (5H) per lite of glass
Window height	76.001" - 84"	= 7 lites down (6H) per lite of glass

Awning & Casement Picture Window (AW/CAPW740)

FEATURES:

- 1/2" flange frame
- 5/16" laminated glass
- Folding nesting handle
- Multi-point lock system
- Extruded screen with 1816 charcoal mesh

OPTIONS:

- Commodity, Modular, and Custom sizes
- Laminated insulating glass
- EnergyShield & EnergyShield Max Low-E
- Argon gas
- Stainless steel hardware package
- High design pressure options

PERFORMANCE:

Awning

- Flange sizes up to 60" x 39" or 27-7/8" x 84"
- Design pressures up to +90/-130

Casement Fixed Lite Picture Window

- Flange sizes up to 32 square feet
- Design pressures up to +90/-130

COMPANION PRODUCTS:

- CA740, CAPW740
- Modular design with matching Casement and Fixed Lite Picture Window for multiple configurations including X, XX, XO, O

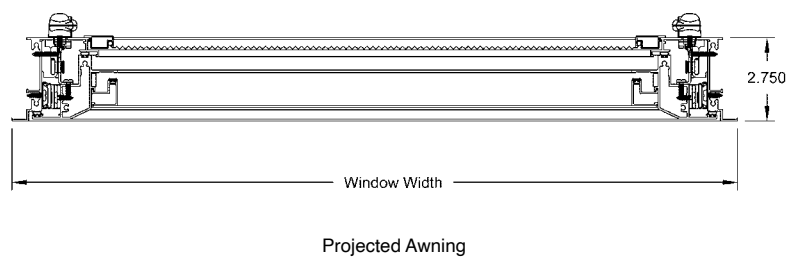
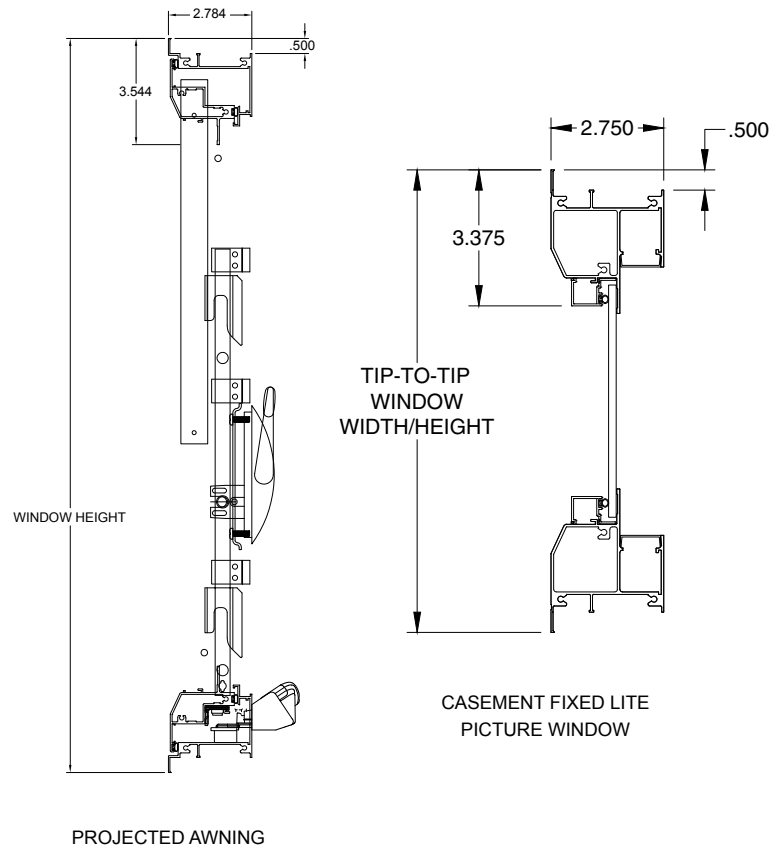

Awning & Casement Picture Window (AW/CAPW740)

STANDARD LITES FOR COLONIAL GRIDS

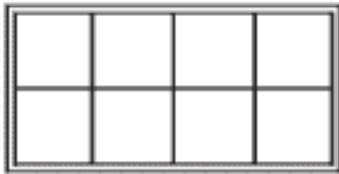

Projected Awning Configuration		
Window width	Up to 30"	= 2 lites across (1V) per lite of glass
Window width	30.001" - 37"	= 3 lites across (2V) per lite of glass
Window width	37.001" - 60"	= 4 lites across (3V) per lite of glass
Window height	Up to 30"	= 2 lites down (1H) per lite of glass
Window height	30.001" - 40"	= 3 lites down (2H) per lite of glass
Window height	40.001" - 51"	= 4 lites down (3H) per lite of glass
Window height	51.001" - 65"	= 5 lites down (4H) per lite of glass
Window height	65.001" - 76"	= 6 lites down (5H) per lite of glass
Window height	76.001" - 84"	= 7 lites down (6H) per lite of glass

Fixed Lite Picture Window & Architecturals

(PW/AR7720A)

FEATURES:

- 1/2" flange frame
- 7/16" laminated glass
- Standard style picture window
- Various architectural shapes

OPTIONS:

- Custom sizes
- Integral Nail Fin & Equal Leg frame
- Laminated insulating glass
- EnergyShield & EnergyShield Max Low-E
- Argon gas
- Stainless steel assembly screws
- High design pressure options

PERFORMANCE:

- Flange sizes up to 42 square feet
- Design pressures up to +90/-130



HALF CIRCLE

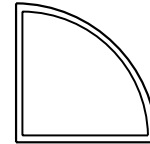

QUARTER CIRCLE



EYEBROW

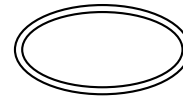

OVAL

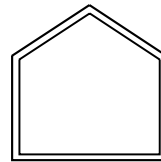

PEAK PENTAGON



ARCH

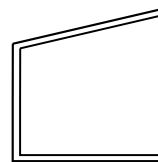

TRAPEZOID

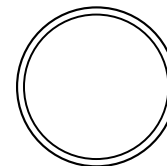

FULL CIRCLE

Fixed Lite Picture Window & Architecturals (PW/AR7720A)

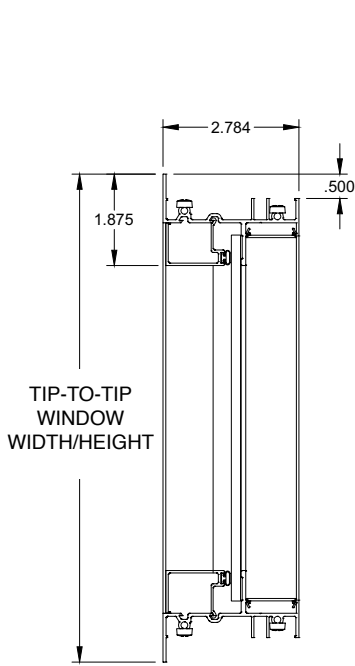

FLANGE

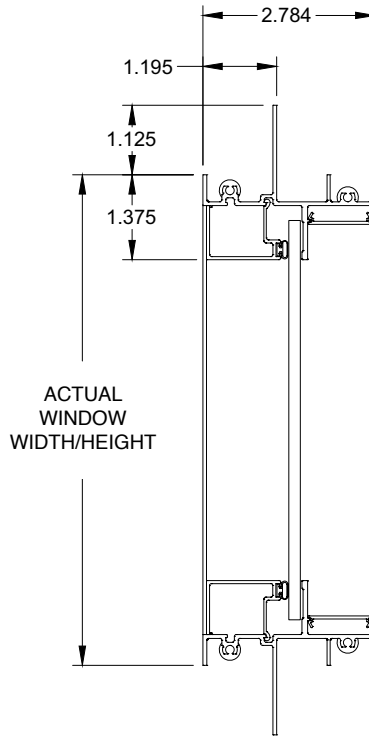

INTEGRAL NAIL FIN

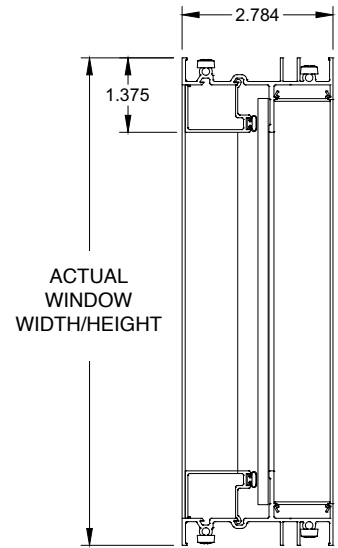

EQUAL LEG

D O O R S

Preferred Sliding Glass Door (SGD770)

FEATURES:

- 7/16" laminated glass
- 2, 3, or 4 tracks
- 2-1/2" Clear Anodize sill
- Multi-panel by-pass and pocket configurations
- Dual-point mortise lock
- Tandem steel roller assembly

OPTIONS:

- Nominal and Custom sizes
- Configurations up to 8 panels
- Laminated insulating glass
- EnergyShield & EnergyShield Max Low-E
- Argon gas
- 90° and 135° corner door configurations
- Inside or outside corner configurations
- Counter top unit (sliding glass window)
- Stainless steel roller assembly
- Various sill risers
- Raised, Curved, or Contemporary handles
- Recessed pull with lock
- Secondary lock
- Reversible interlock
- Standard or box screen
- High design pressure options

PERFORMANCE:

- Panel sizes up to 5'0" x 8'0" or 4'0" x 10'0"
- Design pressures up to +90/-130

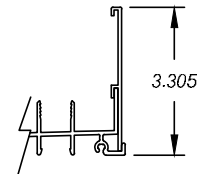
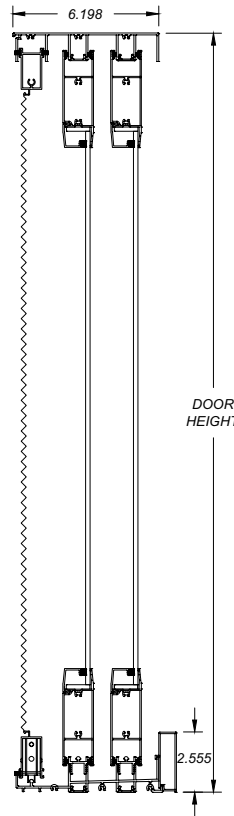

NARROW
SILLED

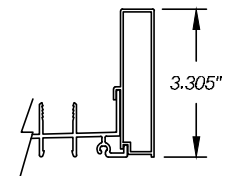

BOX RISER

**NOMINAL SILL
RISER HEIGHTS**

Flush	1.500"
Low	2.500"
Medium	3.250"
High	4.000"

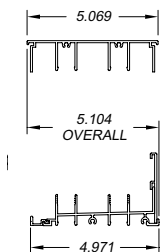
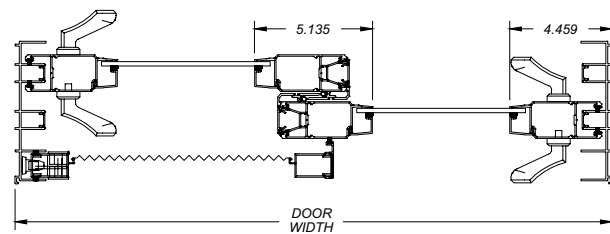

2-Track Frame Depth
For Box Riser add .590"

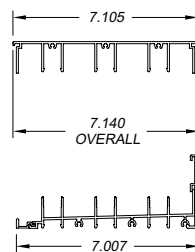

3-Track Frame Depth
For Box Riser add .590"

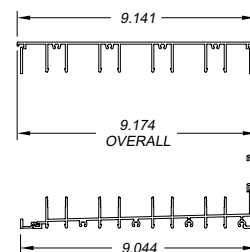

4-Track Frame Depth
For Box Riser add .590"

Preferred Sliding Glass Door

(SGD770)

NOMINAL DOOR SIZES

By-Pass Configuration	Size Code	Overall Size Width x Height*
2P2T XO OX XX	4068	48" x 80"
	5068	60" x 80"
	6068	72" x 80"
	8068	96" x 80"
	10068	120" x 80"
3P3T XXX XXO OXX	7668	88 1/8" x 80"
	9068	106 1/8" x 80"
	12068	142 1/8" x 80"
	15068	178 1/8" x 80"
4P2T OXXO XXXX	10068	119 7/16" x 80"
	12068	143 7/16" x 80"
	16068	191 7/16" x 80"
	20068	239 7/16" x 80"
4P4T XXXX OXXX XXXO	10068	116 3/16" x 80"
	12068	140 3/16" x 80"
	16068	188 3/16" x 80"
	20068	236 3/16" x 80"
3P2T OXX XXO OXO	7668	91 5/16" x 80"
	9068	109 5/16" x 80"
	12068	145 5/16" x 80"
	15068	181 5/16" x 80"
5P3T XXX-XX, XX-XXX OX-XXO, OXX-XO	15068	177 1/2" x 80"
	20068	237 1/2" x 80"
	25068	297 1/2" x 80"
6P3T OXX-XXO XXX-XXX	15068	175 5/8" x 80"
	18068	211 5/8" x 80"
	24068	283 5/8" x 80"
	30068	355 5/8" x 80"
8P4T OXXX-XXXO XXXX-XXXX	20068	231 7/8" x 80"
	24068	279 7/8" x 80"
	32068	375 7/8" x 80"
	40068	471 7/8" x 80"

* 6/8 heights shown

Pocket Configuration	Size Code	Overall Size Width x Height*
1P2T 1 POCKET	3068	35 1/4" x 80"
	4068	47 1/4" x 80"
	5068	59 1/4" x 80"
2P2T 1 POCKET	4068	45 3/8" x 80"
	5068	57 3/8" x 80"
	6068	69 3/8" x 80"
	8068	93 3/8" x 80"
3P3T 1 POCKET	7668	85 7/16" x 80"
	9068	103 7/16" x 80"
	12068	139 7/16" x 80"
	15068	175 7/16" x 80"
4P4T 1 POCKET	10068	113 9/16" x 80"
	12068	137 9/16" x 80"
	16068	185 9/16" x 80"
	20068	233 9/16" x 80"
2P2T 2 POCKET	4068	45 15/16" x 80"
	5068	57 15/16" x 80"
	6068	69 15/16" x 80"
	8068	93 15/16" x 80"
4P2T 2 POCKET	10068	114 1/8" x 80"
	12068	138 1/8" x 80"
	16068	186 1/8" x 80"
	20068	234 1/8" x 80"
6P3T 2 POCKET	15068	170 3/8" x 80"
	18068	206 3/8" x 80"
	24068	278 3/8" x 80"
	30068	350 3/8" x 80"
8P4T 2 POCKET	20068	226 9/16" x 80"
	24068	274 9/16" x 80"
	32068	370 9/16" x 80"
	40068	466 9/16" x 80"

* 6/8 heights shown

STANDARD LITES FOR COLONIAL GRIDS

Standard Lites for Colonial Grids		
Nominal panel width	Up to 2'6"	=2 lites across (1V) per panel
Nominal panel width	3'0" & 4'0"	=3 lites across (2V) per panel
Nominal panel width	5'0"	=4 lites across (3V) per panel
Nominal panel height	6'8"	=5 lites down (4V) per panel
Nominal panel height	8'0"	=6 lites down (5V) per panel
Nominal panel height	9'0" & 10'0"	=7 lites down (6V) per panel

Premium Sliding Glass Door

(SGD780)

FEATURES:

- 7/16" laminated glass
- 2, 3, or 4 tracks
- 2-3/4" Clear Anodize sill
- 4" bottom rail
- Multi-panel by-pass and pocket configurations
- Dual-point mortise lock
- Stainless steel tandem roller assembly

OPTIONS:

- Nominal and Custom sizes
- Configurations up to 8 panels
- 9" bottom rail
- Laminated insulating glass
- EnergyShield & EnergyShield Max Low-E
- Argon gas
- 90° and 135° corner door configurations
- Inside or outside corner configurations
- Various sill risers
- Curved or Contemporary handles
- Secondary lock
- Box screen
- High design pressure options

PERFORMANCE:

- Panel sizes up to 5'0" x 10'0" or 4'0" x 12'0"
- Design pressures up to +105/-115

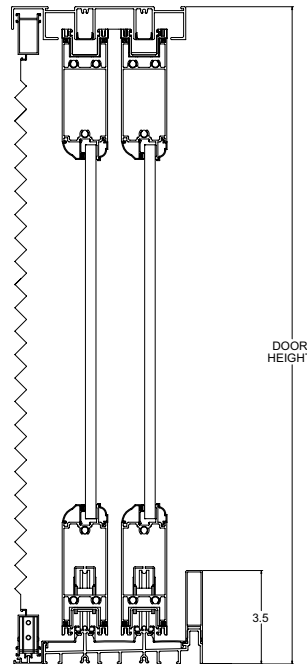

SILL RISER



NOMINAL SILL RISER HEIGHTS

Flush	1.625"
Standard	2.750"
Low	3.500"
Medium	4.500"
High	5.250"

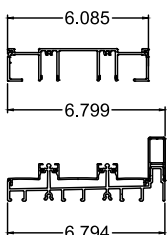
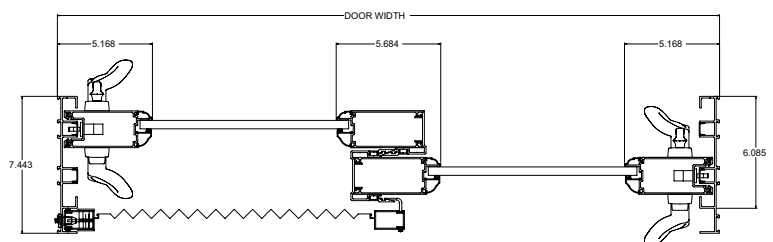

2-Track Frame Depth

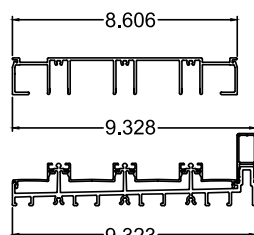

3-Track Frame Depth



4-Track Frame Depth

Premium Sliding Glass Door

(SGD780)

NOMINAL DOOR SIZES

By-Pass Configuration	Size Code	Overall Size Width x Height*
2P2T XO OX XX	5068	60" x 80"
	6068	72" x 80"
	8068	96" x 80"
	10068	120" x 80"
3P3T XXX XXO OXX	7668	87 11/16" x 80"
	9068	105 11/16" x 80"
	12068	141 11/16" x 80"
	15068	177 11/16" x 80"
4P2T OXXO XXXX	10068	119 7/16" x 80"
	12068	143 7/16" x 80"
	16068	191 7/16" x 80"
	20068	239 7/16" x 80"
4P4T XXXX OXXX XXXXO	10068	115 3/8" x 80"
	12068	139 3/8" x 80"
	16068	187 3/8" x 80"
	20068	235 3/8" x 80"
3P2T OXO	9068	109 3/4" x 80"
	12068	145 3/4" x 80"
	15068	181 3/4" x 80"
6P3T OXX-XXO XXX-XXX	15068	174 3/4" x 80"
	18068	210 3/4" x 80"
	24068	282 3/4" x 80"
	30068	354 3/4" x 80"
8P4T OXXX-XXXXO XXXX-XXXX	20068	230 3/16" x 80"
	24068	278 3/16" x 80"
	32068	374 3/16" x 80"
	40068	470 3/16" x 80"

* 6/8 heights shown

Pocket Configuration	Size Code	Overall Size Width x Height*
1P2T 1 POCKET	3068	34 7/16" x 80"
	4068	46 7/16" x 80"
	5068	58 7/16" x 80"
2P2T 1 POCKET	5068	56 1/8" x 80"
	6068	68 1/8" x 80"
	8068	92 1/8" x 80"
	10068	116 1/8" x 80"
3P3T 1 POCKET	7668	83 13/16" x 80"
	9068	101 13/16" x 80"
	12068	137 13/16" x 80"
	15068	173 13/16" x 80"
4P4T 1 POCKET	10068	111 1/2" x 80"
	12068	135 1/2" x 80"
	16068	183 1/2" x 80"
2P2T 2 POCKET	20068	231 1/2" x 80"
	5068	56 3/8" x 80"
	6068	68 3/8" x 80"
	8068	92 3/8" x 80"
4P2T 2 POCKET	10068	111 11/16" x 80"
	12068	135 11/16" x 80"
	16068	183 11/16" x 80"
	20068	231 11/16" x 80"
6P3T 2 POCKET	15068	167 1/16" x 80"
	18068	203 1/16" x 80"
	24068	275 1/16" x 80"
	30068	347 1/16" x 80"
8P4T 2 POCKET	20068	222 3/8" x 80"
	24068	270 3/8" x 80"
	32068	366 3/8" x 80"
	40068	462 3/8" x 80"

* 6/8 heights shown

STANDARD LITES FOR COLONIAL GRIDS

Standard Lites for Colonial Grids		
Nominal panel width	Up to 2'6"	=2 lites across (1V) per panel
Nominal panel width	3'0" & 4'0"	=3 lites across (2V) per panel
Nominal panel width	5'0"	=4 lites across (3V) per panel
Nominal panel height	6'8"	=5 lites down (4V) per panel
Nominal panel height	8'0"	=6 lites down (5V) per panel
Nominal panel height	9'0" & 10'0"	=7 lites down (6V) per panel
Nominal panel height	12'0"	=8 lites down (7V) per panel

Preferred/Premium Sliding Glass Door (SGD770/780)

These panel configurations apply to both the Preferred Sliding Glass Door (SGD770) and the Premium Sliding Glass Door (SGD780) when available.

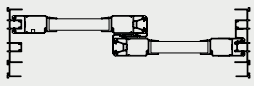
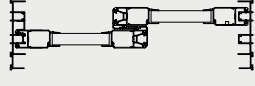
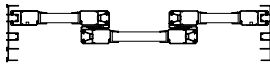
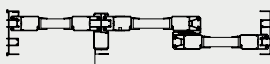
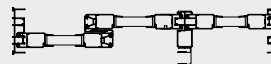
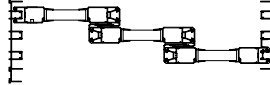
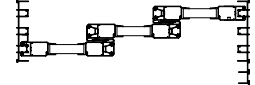
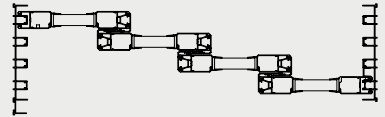
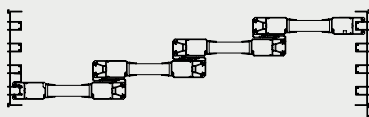
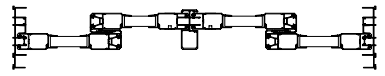
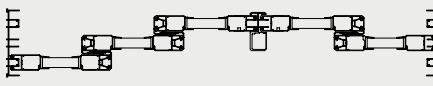
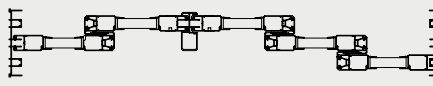
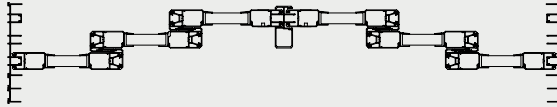
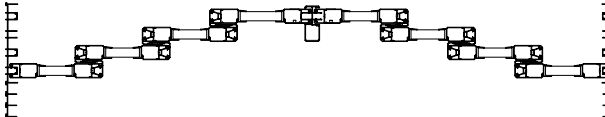
TYPE	STANDARD STACK	REVERSE STACK
2P2T XX / XO / OX		
3P2T XOX		SAME AS STANDARD STACK
3P2T OXO		
3P3T XXX / XO / OXX		
4P4T XXXX / XXXO / OXXX		
4P2T XXXX / OXXO		SAME AS STANDARD STACK
5P3T OXX-XO / OX-XXO XXX-XX / XX-XXX		
TYPE	STANDARD STACK	
6P3T OXX-XXO XXX-XXX		
8P4T OXXX-XXXX XXXX-XXXX		

Essential French Door

(FD101H)

FEATURES:

- 3/8" laminated glass
- Single or double door
- Outswing
- 1-1/2" Clear Anodize bumper threshold
- Pre-hung slab with 7" hinges
- 2-point locking system
- 2-1/8" bore with 2-3/8" setback
- Handle and deadbolt bore 4" on-center

OPTIONS:

- Nominal and Custom sizes
- Laminated insulating glass
- EnergyShield & EnergyShield Max Low-E
- Argon gas
- Handle and deadbolt bore 5", 5-1/2", or 6" on-center
- Sidelite

PERFORMANCE:

- Single door sizes up to 37-1/2" x 95-3/4"
- Double door sizes up to 71-3/4" x 95-3/4"
- Sidelite sizes up to 36-3/4" x 95-3/4"
- Design pressures up to +75/-75

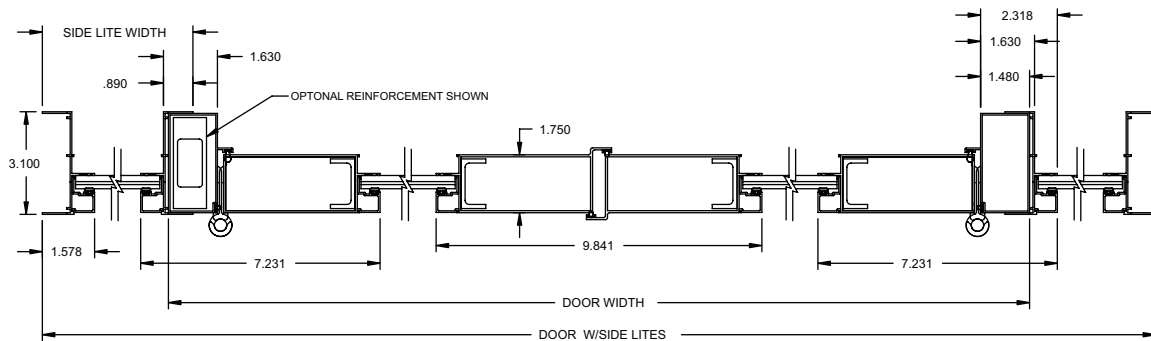
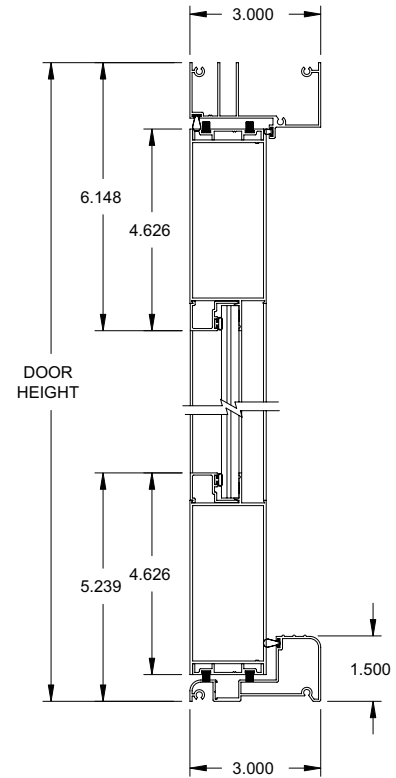

NOMINAL SIZES

SINGLE DOOR	Width		
Height	31 1/2"	33 1/2"	37 1/2"
79 3/4"	2668	2868	3068
95 3/4"	2680	2880	3080

NOMINAL SIZES

DOUBLE DOOR	Width			
Height	47 3/4"	59 3/4"	63 3/4"	71 3/4"
79 3/4"	4068	5068	5468	6068
95 3/4"	4080	5080	5480	6080

EGRESS FORMULA

	Single Door	Double Door
Clear Opening Width	Door Width - 5.646"	(Door Width / 2) - 4.079"
Clear Opening Height	Door Height - 3.259"	Door Height - 3.259"

Egress Formulas are based upon standard door features. Material or design changes may be made without notice or liability. In the event of discrepancies, only those egress opening sizes displayed in ClearQuote will be honored.

STANDARD LITES FOR COLONIAL GRIDS

Standard Lites for Colonial Grids		
Single door width	Up to 31.500"	=2 lites across (1V) per panel
Single door width	31.501" - 37.500"	=3 lites across (2V) per panel
Double door width	Up to 62"	=2 lites across (1V) per panel
Double door width	62.001" - 71.750"	=3 lites across (2V) per panel
Door height	Up to 87"	=5 lites down (4V) per panel
Door height	87.001" - 95.750"	=6 lites down (5V) per panel

Preferred French Door

(FD750)

FEATURES:

- 7/16" laminated glass
- Single or double door
- Outswing
- 2-1/4" Clear Anodize bumper threshold
- Continuous gear hinge
- Multi-point locking system
- 9" kick rail
- Bore prep designed for use with European style hardware
- Stainless steel hardware (except handles)

OPTIONS:

- Nominal and Custom sizes
- 1-3/8" low sill
- Laminated insulating glass
- EnergyShield & EnergyShield Max Low-E
- Argon gas
- Full Jamb sidelite
- Narrow Jamb sidelite

PERFORMANCE:

- Single door sizes up to 37" x 95-3/4"
- Double door sizes up to 71-3/4" x 95-3/4"
- Full Jamb sidelite sizes up to 36-11/16" x 95-3/4"
- Narrow Jamb sidelite sizes up to 36-11/16" x 95-3/4"
- Design pressures up to +100/-100

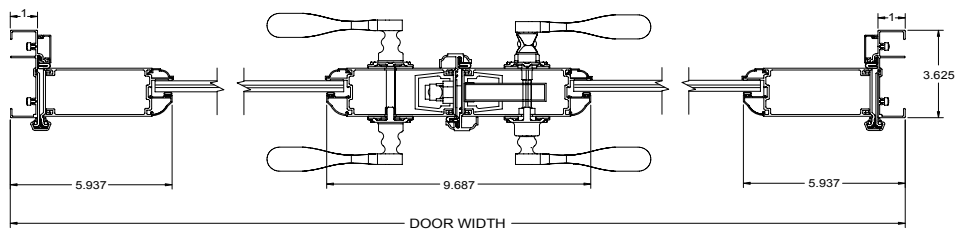
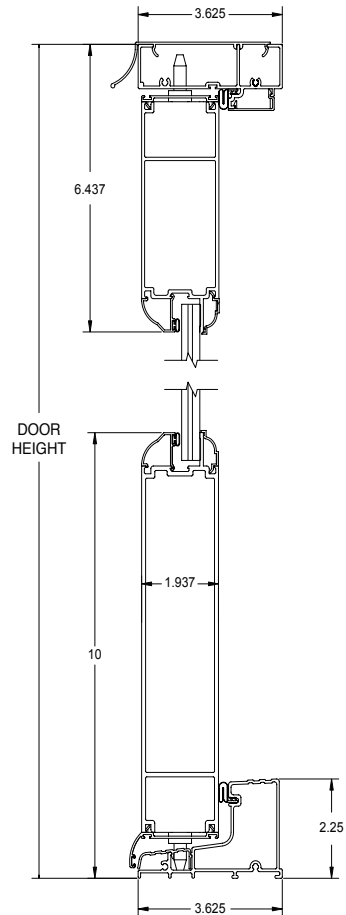

NOMINAL SIZES

SINGLE DOOR	Width		
Height	31"	33"	37"
79 3/4"	2668	2868	3068
95 3/4"	2680	2880	3080

NOMINAL SIZES

DOUBLE DOOR	Width	
Height	59 3/4"	71 3/4"
79 3/4"	5068	6068
95 3/4"	5080	6080

EGRESS FORMULA

	Single Door	Double Door
Clear Opening Width	Door Width - 4.875"	Door Width / 2 - 3.750"
Clear Opening Height	Door Height - 3.750"	Door Height - 3.750"

Egress Formulas are based upon standard door features. Material or design changes may be made without notice or liability. In the event of discrepancies, only those egress opening sizes displayed in ClearQuote will be honored.

STANDARD LITES FOR COLONIAL GRIDS

Standard Lites for Colonial Grids		
Single door width	Up to 31"	=2 lites across (1V) per panel
Single door width	31.001" - 37"	=3 lites across (2V) per panel
Double door width	Up to 62"	=2 lites across (1V) per panel
Double door width	62.001" - 71.750"	=3 lites across (2V) per panel
Door height	Up to 87"	=5 lites down (4V) per panel
Door height	87.001" - 95.750"	=6 lites down (5V) per panel



INVENT. BUILD. DELIVER.

A collection of the best brands in windows and doors coming together to invent, build, and deliver the highest-quality and safest products in the fenestration industry.

THE PGT INNOVATIONS FAMILY OF BRANDS



PGTWINDOWS.COM | N. VENICE, FL

©2020 PGT CUSTOM WINDOWS + DOORS. A PGT INNOVATIONS BRAND.

04/20 MB0300424