



**P&G ClassicVue Max™**

**P&G WinGuard®**  
ALUMINUM

AW640 / AW740

This reference guide is to help identify parts and ordering options.

## FRAME PARTS



Nesting handle  
*(color matched to frame)*  
*(Left hand only)*



Upgraded nesting handle  
*Oil Rubbed Bronze, Antique Brass,*  
*Brushed Nickel*



Multi point lock  
*(color matched to frame)*



**Construction handle**  
*(prevents damage until the handle is installed)*

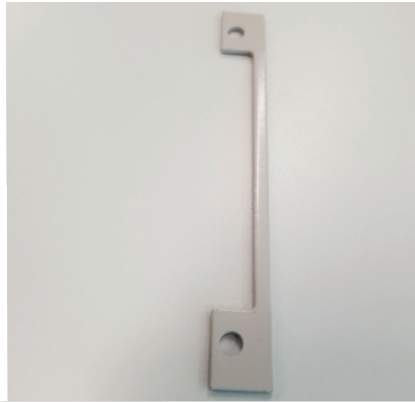

**Multi point lock support plate**



**Operator backing plate**

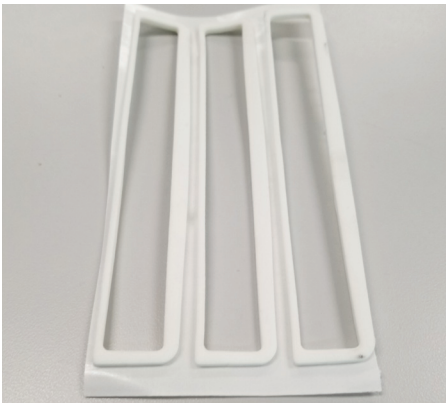

**Operator gasket**



**Operator spacer block**



**Scissor operator**



**12" Hinge**  
*(Unit height less than 25")*



**16" Hinge**  
*(unit height is 25" to 33.999")*



**20" Hinge**  
*(unit height 34" to 63.999")*



Tie bar

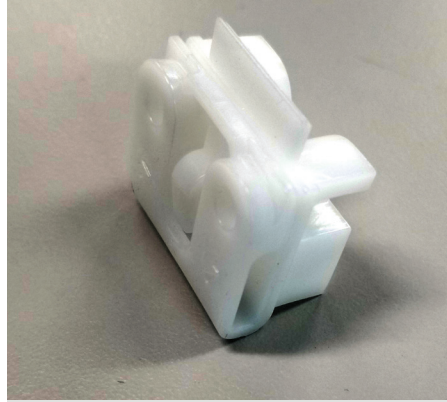

Tie bar guide



Continuous nail fin  
*(640 series only)*

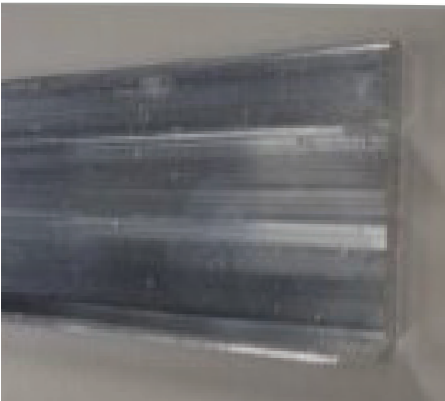

Anchor plate

## VENT PARTS



Operator track



Maxim pivot slider



Operator slide lock



Snubbers



Multi point lock keeper



Sash limiter

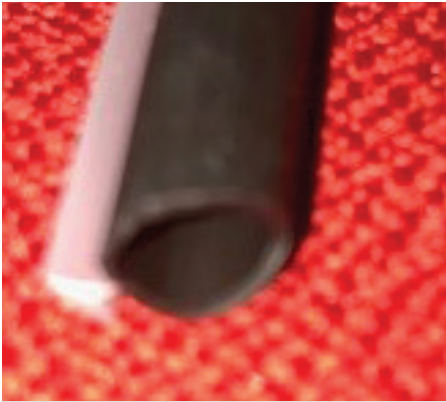

Bulb weather-strip  
*(frame=double perimeter)*  
*(sash= single perimeter towards exterior)*

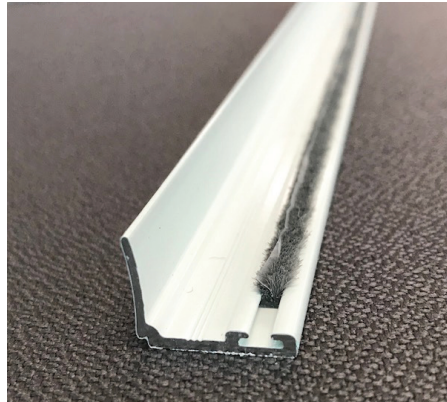

IG bead  
*(varies depending on glass type)*

## SCREEN PARTS



Screen corner key - extruded



Tension spring



Screen clip

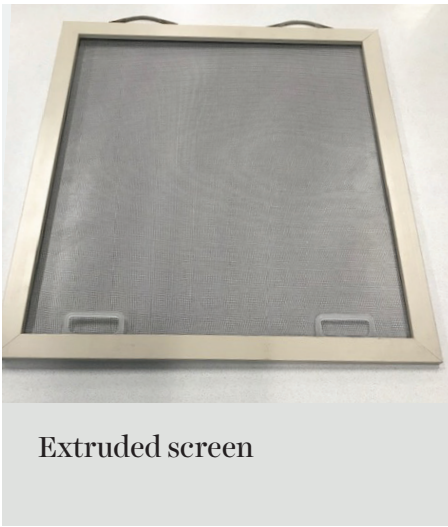

**EXPLODED VIEWS**

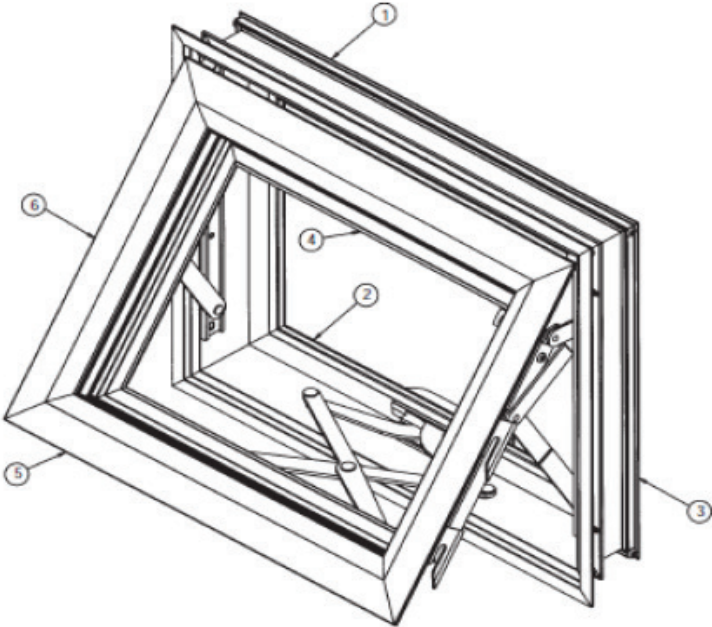

- 1. Frame head
- 2. Frame sill
- 3. Frame jamb
- 4. Vent top rail
- 5. Vent bottom rail
- 6. Vent side rail

