



PGT EnergyVue®

PGT WinGuard®
VINYL

CA5440 / CA5540

This reference guide is to help identify parts and ordering options.

FRAME PARTS



Nesting handle
(color matched to frame)



Upgraded nesting handle
*Oil Rubbed Bronze, Antique Brass,
Brushed Nickel*



Worm
(silver is left, gold is right)



Multi-point lock
(color matched to frame)



Construction handle
(prevents damage until nesting handle is installed)



Multi point lock support plate



Operator backing plate

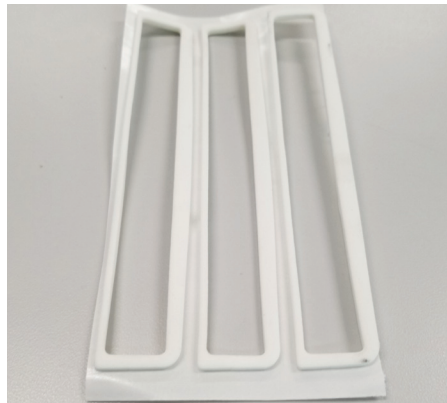

Operator gasket



Dyad operator
(units less than or equal to 24.25" wide)



Dual arm operator
(units over 24.25" wide)



Heavy duty dual arm operator
(based on unit size/weight)



Washable hinge



Egress hinge



Heavy duty Truehold hinge



Tie bar

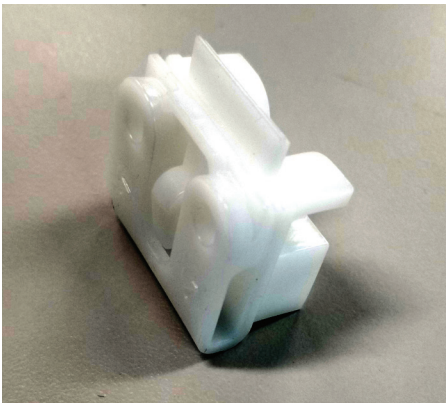

Tie bar guide



Top angle bracket

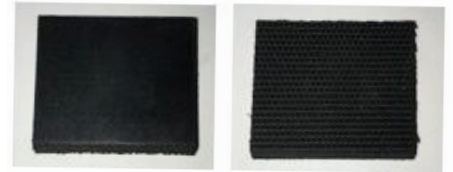

WOCD spacer



Sash limiter (WOCD)



7/16" Installation hole plug
(color matched to frame)

VENT PARTS



Operator track slider



Dual arm track

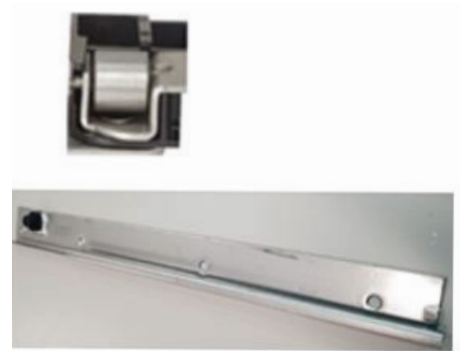

Heavy duty hinge track & roller



Heavy duty dual arm track



Stud bracket



Heavy duty stud bracket

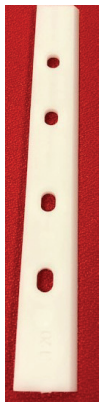

Standard stud bracket spacer



Heavy duty snubber



Standard snubber



Multi point lock keeper



Bulb weather strip
(frame = double perimeter)
(sash = single perimeter towards exterior)

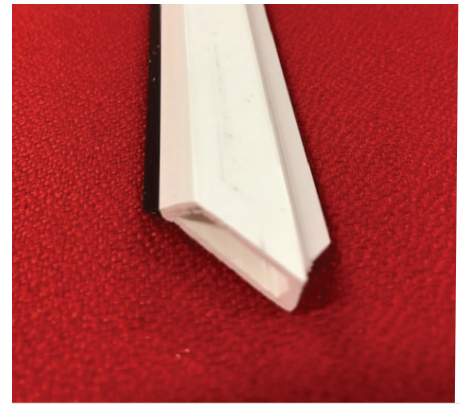

IG bead
(varies depending on glass type)

SCREEN PARTS



Screen corner key - extruded



Tension spring

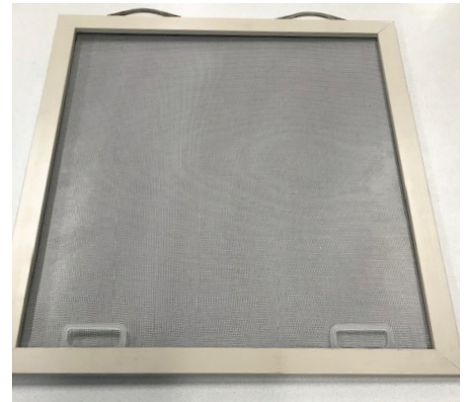

Extruded screen

EXPLODED VIEWS

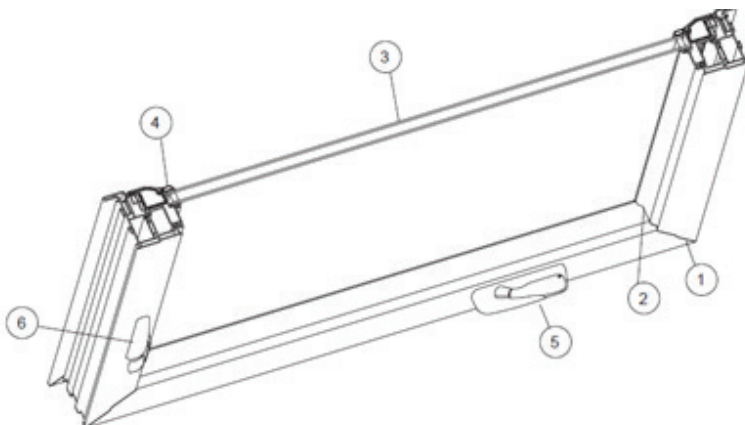

Figure # Description

1. Frame
2. Vent
3. 3/4" insulating glass
4. Dual durometer glazing bead
5. Operator w/ nesting handle
6. Lever lock