



PGT EnergyVue®

PGT WinGuard®
VINYL

SH5400 / SH5500

This reference guide is to help identify parts and ordering options.

FRAME PARTS



Constant force balance



Spiral balance
(Ultra-lift)



Spiral balance
(Eze-lift)

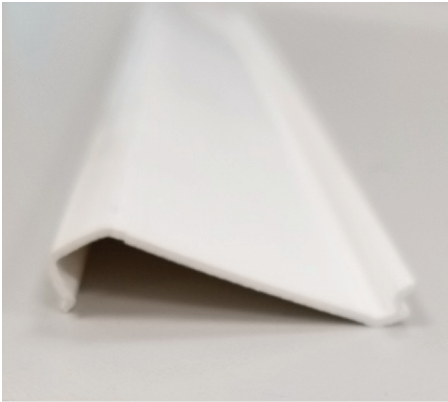

Balance cover
(used with spiral balances only)



Balance top clip
constant force



Balance shoe

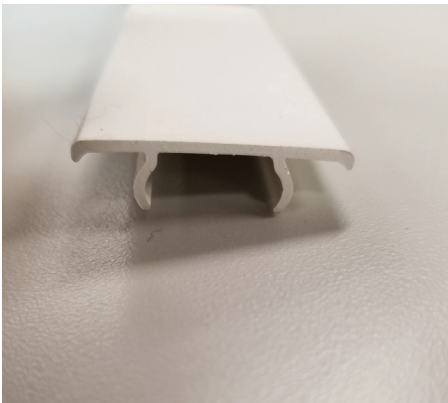

Sash stop



Keeper
(color matched to frame)

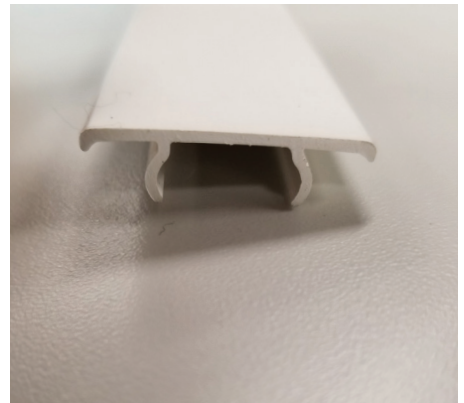

Fastener Cover
(in the frame head, same as sash stop)



0.438" Installation hole plug
(color matched to frame)



WOCD
(automatically engages)



Vent latches
(manually engages)



Weep hole cover
(color matched to frame)

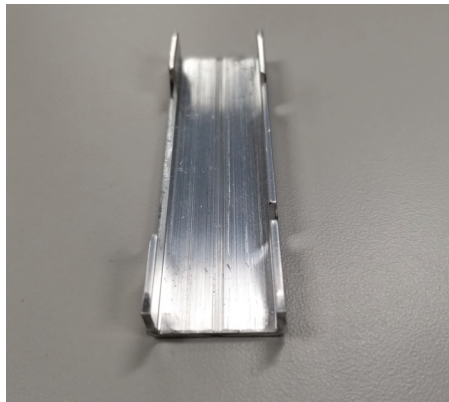

WOCD reinforcement

SASH PARTS



Sash lock
(color matched to frame)



Upgraded sash lock finish
*Oil rubbed bronze, Brushed nickel,
Antique brass*

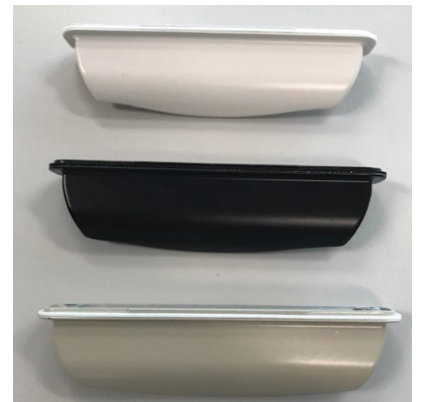

Comfort lift handles
(color matched to frame)

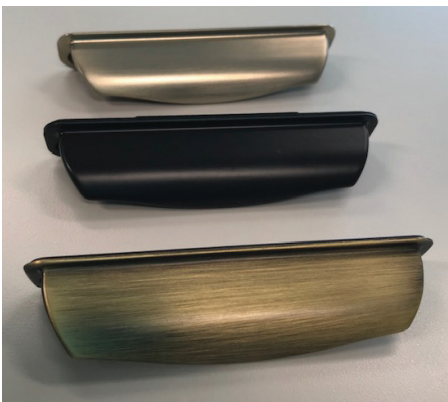

Upgraded comfort lift finish
*Oil rubbed bronze, Brushed nickel,
Antique brass*



Egress lock
(color matched to frame)



Secure connect sash corner
(lift rail and beveled rail)



Secure connect pivot bar

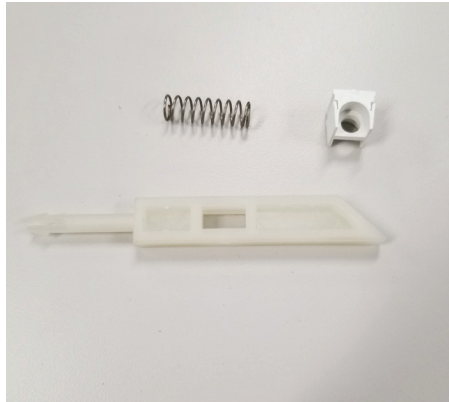

Tilt latch

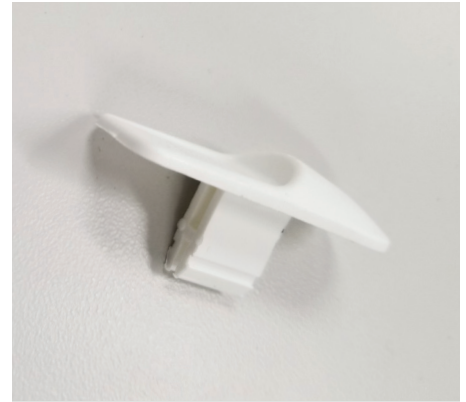

Tilt latch finger pull
(color matched to frame)



Bulb weather-strip
(side rails and exterior of sill)



Fin seal weather-strip
*(meeting rail and sill)
(perimeter on interior sash)*



Lift rail cover
(comes with reinforcement)



Sash interlock cover-beveled
(comes with reinforcement)

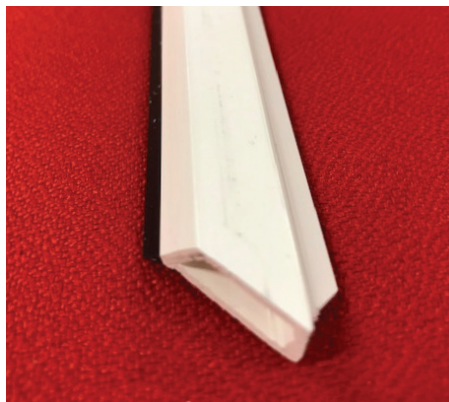

IG bead
(varies depending on glass type)

SCREEN PARTS



Screen corner key - extruded

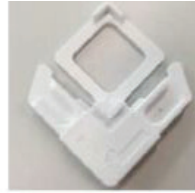

Screen corner key - roll form



Tension spring



Roll form screen

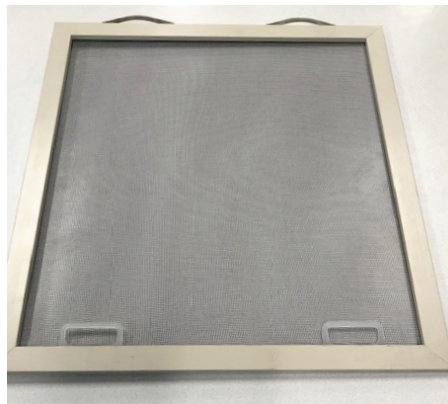

Extruded screen

EXPLODED VIEWS

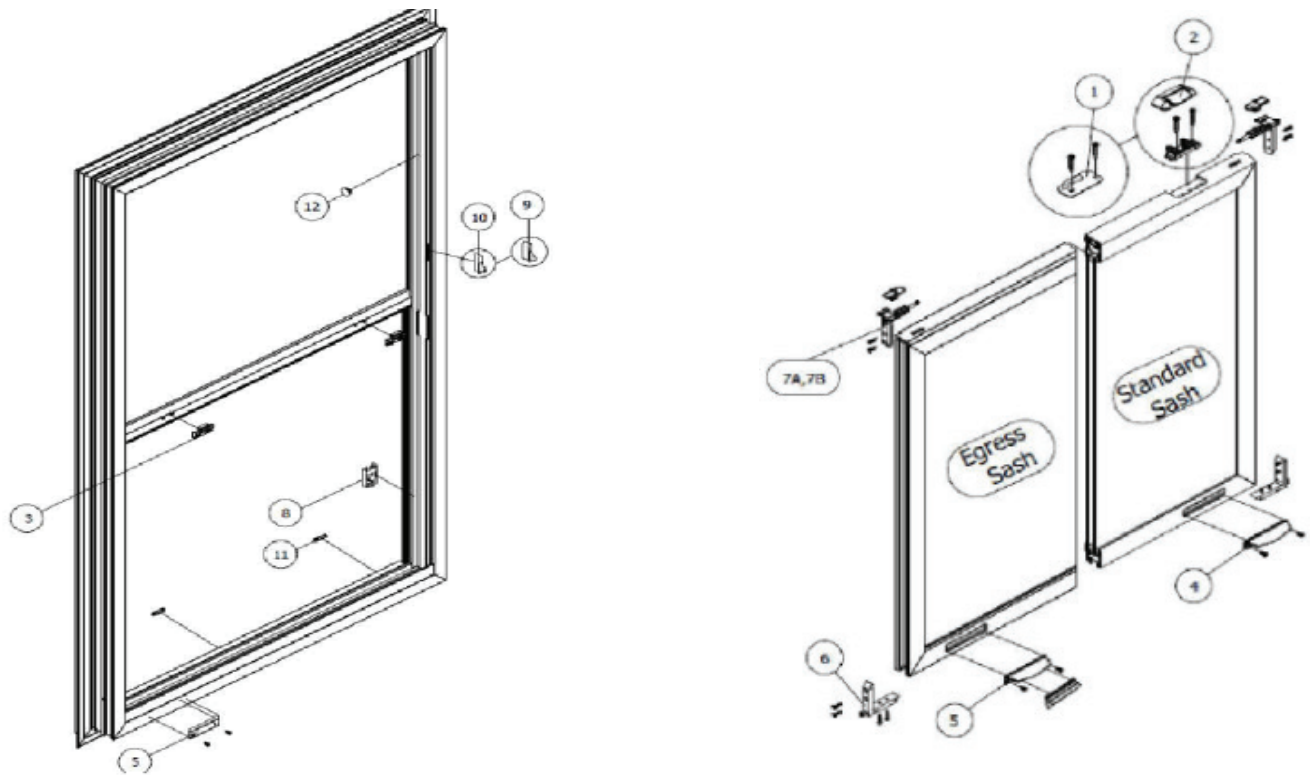

PARTS LIST	
ITEM	NAME
1	Sweep Lock with Screws
2	SnapLock Cover, Mechanism with Screws
3	Keeper
4	Comfort Lift Handle with Screws
5	Egress Bottom Lock Assembly with Keeper and Screws
6	SecureConnect Pivot Bar Assembly
7A	SecureConnect Tilt Latch Assembly with Fin Seal (L-R)
7B	SecureConnect Tilt Latch Assembly Lift Rail with Fin Seal (L-R)
8	Spiral Balance Shoe
9	Vent Latch
10	Window Opening Control Device (W OCD)
11	Weep Hole Cover
12	7/16" Installation Hole Plug